



HD Network Camera

Quick start guide

IP CAMERA

1 Camera Connection Diagram

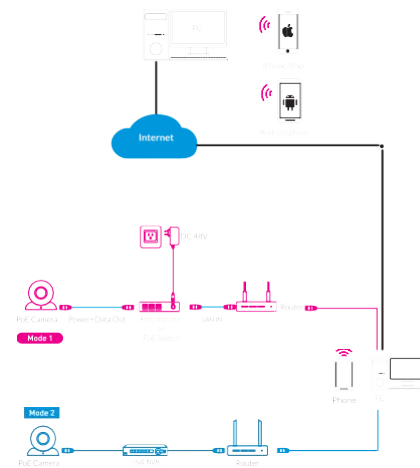

Attention: There are two connection modes:
1. For non-PoE router, pls connect the camera by a PoE switch or a PoE injector.
2. For a POE NVR, pls connect the camera directly to the POE NVR, then follow the below steps.

2 Installation

Bullet Camera Installation
Ceiling Mounting

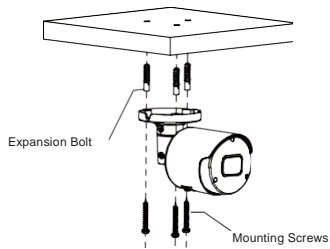

Insert three expansion bolts in place into the ceiling and fix the equipment with three mounting screws.

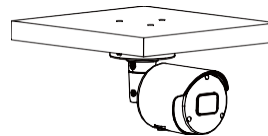

Completion of Installation

Dome Camera Installation

Ceiling Mounting

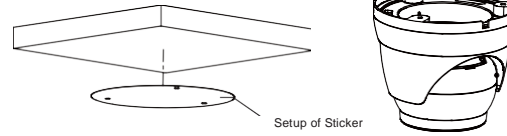

Paste the sticker in place at the proper position as selected.

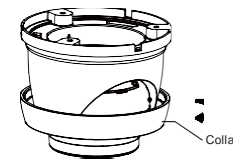

Remove the collar off the camera by rotating it down

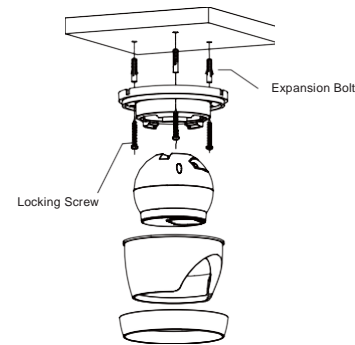

Fix the pedestal by drilling locking holes around the sticker and inserting three expansion bolts into the holes and fastening it with three locking screws.

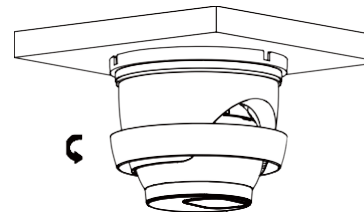

Mount the collar back by rotating it up

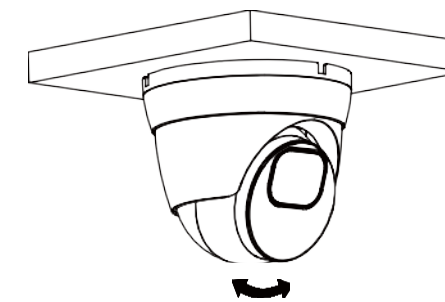

Adjust it to an appropriate angle.

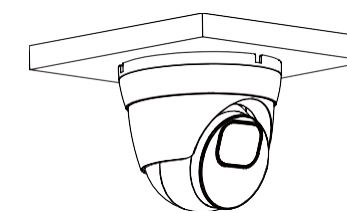

Completion of Installation

Vandal-Proof Dome Camera Installation

Ceiling Mounting

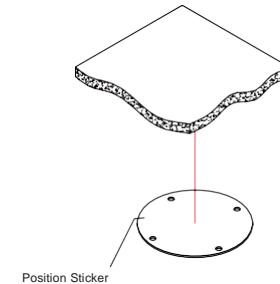

Apply the position sticker to the desired camera mounting position.

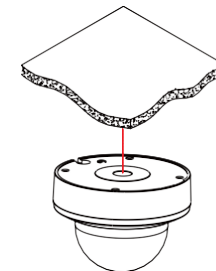

Cover Component

Remove the cover component by loosening the three locking screws with the included hex wrench.

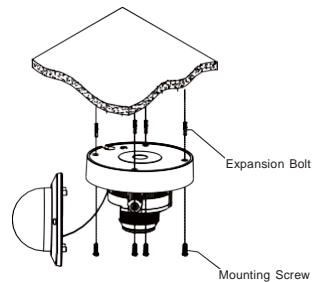

Use the position indicated on the position sticker to drill the holes needed to mount the camera base. Insert the expansion bolt into the holes. Match the base's mount openings to the expansion bolts position, then place the mounting screws through the base's mount opening into the expansion bolt. Tighten the mounting screws to ensure the camera base mounted securely.

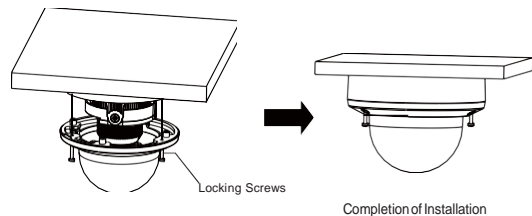

- ※ Place the cover component back onto the base.
- ※ Please make sure the locking screw position on the cover component matches the locking post on the base.
- ※ Tighten the locking screws after the cover component is in the correct position.

3 Install the APP

There are two methods to install the App.

Search for "SmartGuardian" in App Store or Google Play.

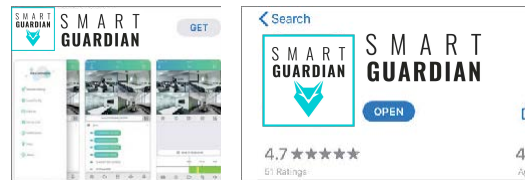

Scan the QR code below to download the App.



4 Camera Settings

Open "Smart Guardian", you will see the following interface to add the cameras.

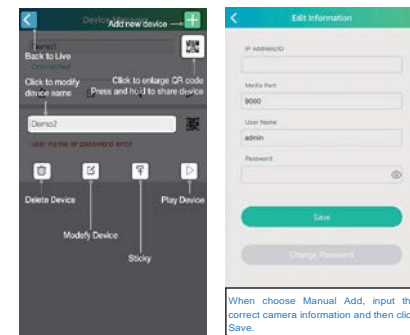
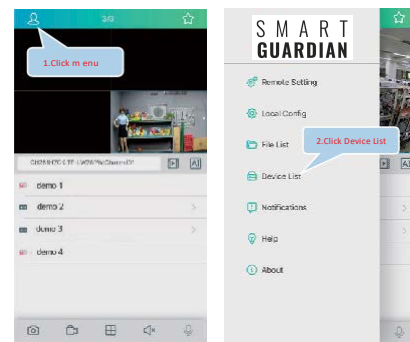

When choose Manual Add, input the correct camera information and then click Save.

If add the device successfully, you will see the following interface.

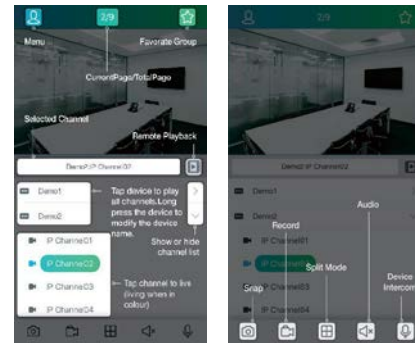

※ Please refer to "Help" section for more detailed instruction.

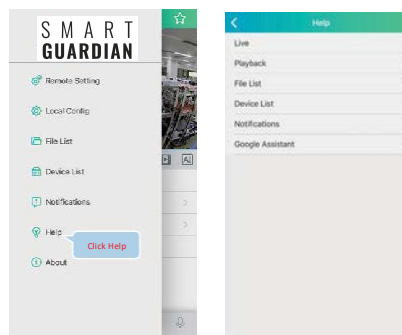

5 In Windows

1. Log on to the website www.GSDGROUP.ca, click on "Support" then "Software" to download "CD SOFTWARE FOR IPC"



2. Under "Device Config Tool", you can modify the information of a selected device. Including IP, Media Port, Web Port, Gateway, Net Mask, Net Mode. (The default username is : admin & password is: 123456)

IP	Media Port	Web Port	Protocol	Device Name	Device Location	Port No
192.168.1.1	8080	80	HTTP	192.168.1.1	192.168.1.1	200,200
192.168.1.2	8080	80	HTTP	192.168.1.2	192.168.1.2	200,200
192.168.1.3	8080	80	HTTP	192.168.1.3	192.168.1.3	200,200
192.168.1.4	8080	80	HTTP	192.168.1.4	192.168.1.4	200,200
192.168.1.5	8080	80	HTTP	192.168.1.5	192.168.1.5	200,200
192.168.1.6	8080	80	HTTP	192.168.1.6	192.168.1.6	200,200
192.168.1.7	8080	80	HTTP	192.168.1.7	192.168.1.7	200,200
192.168.1.8	8080	80	HTTP	192.168.1.8	192.168.1.8	200,200
192.168.1.9	8080	80	HTTP	192.168.1.9	192.168.1.9	200,200
192.168.1.10	8080	80	HTTP	192.168.1.10	192.168.1.10	200,200
192.168.1.11	8080	80	HTTP	192.168.1.11	192.168.1.11	200,200
192.168.1.12	8080	80	HTTP	192.168.1.12	192.168.1.12	200,200
192.168.1.13	8080	80	HTTP	192.168.1.13	192.168.1.13	200,200
192.168.1.14	8080	80	HTTP	192.168.1.14	192.168.1.14	200,200
192.168.1.15	8080	80	HTTP	192.168.1.15	192.168.1.15	200,200
192.168.1.16	8080	80	HTTP	192.168.1.16	192.168.1.16	200,200
192.168.1.17	8080	80	HTTP	192.168.1.17	192.168.1.17	200,200
192.168.1.18	8080	80	HTTP	192.168.1.18	192.168.1.18	200,200
192.168.1.19	8080	80	HTTP	192.168.1.19	192.168.1.19	200,200
192.168.1.20	8080	80	HTTP	192.168.1.20	192.168.1.20	200,200

3. Open the Internet Explorer and input the device's IP address; Input the username & password in the following interface to login the device.

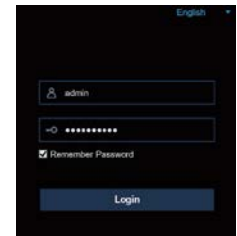

4. After login, click "Remote Setting" to change the setting.

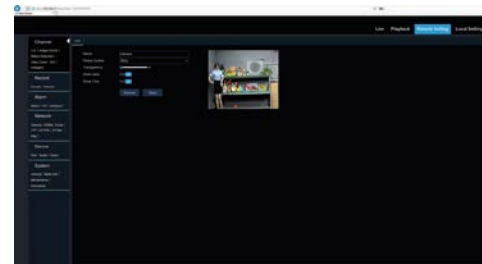

1. Open your router web interface and login.
2. Find the "Attached device" or "Connected device" menu. Find the device's IP address according to its MAC address. The Mac address is labeled on the device.

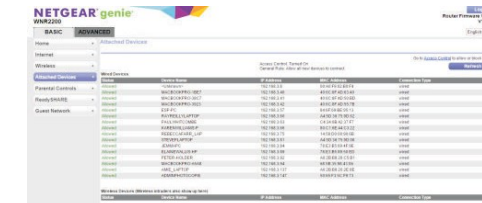

Picture for reference only

3. Input the device's IP address in Safari, login with your username & password.
4. After login, click "Remote Setting" to modify the setting.